

Quick Start Carrier L/XL

903345
01.20.2017

Serie
CR 425-825
S/N 101-1460



VÄDERSTAD

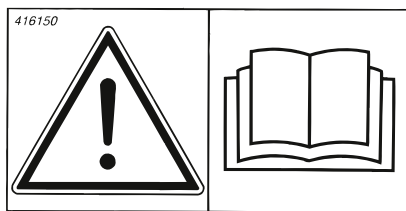

Denna Quickstart ersätter inte instruktionsboken!
Denne Quickstart erstatter ikke instruktionsbogen!
Denne Quickstart erstatter ikke instruksjonsboken!
Tämä Quickstart-pikaopas ei korvaa käyttöohjekirjaa!
This Quickstart guide does not replace the instruction manual!
Diese Quickstart-Anleitung ist kein Ersatz für das Handbuch!
Ce guide Quickstart ne remplace pas le manuel d'instructions!
Instrukcja szybkiego uruchomienia nie zastępuje instrukcji obsługi,
którą należy przeczytać przed rozpoczęciem użytkowania maszyny.
Šis ātrais mācību materiāls neaizvieto lietošanas instrukciju!
Šis „Quickstart“ vadovas nepakeičia instrukcijas!

See kiirjuhend Quickstart ei asenda kasutusjuhendit!
Návod Quickstart nenahrazuje návod k použití!
Ez a Quickstart útmutató nem helyettesíti a Használati útmutatót!
La presente guida Quickstart non sostituisce il manuale di istruzioni!
Это руководство «Quickstart» не заменяет основное
руководство по эксплуатации!
Та водник Quickstart не надомеšча приручника з navodili!
Този бърз справочник не заменя наръчника!
Ο παρών οδηγός Γρήγορης εκκίνησης δεν αντικαθιστά το εγχειρίδιο οδηγιών!



INFO

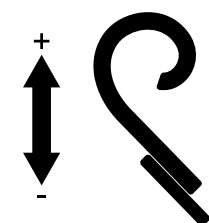
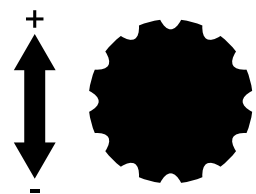
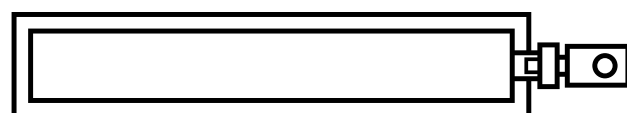
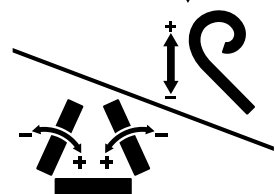
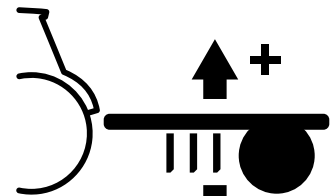
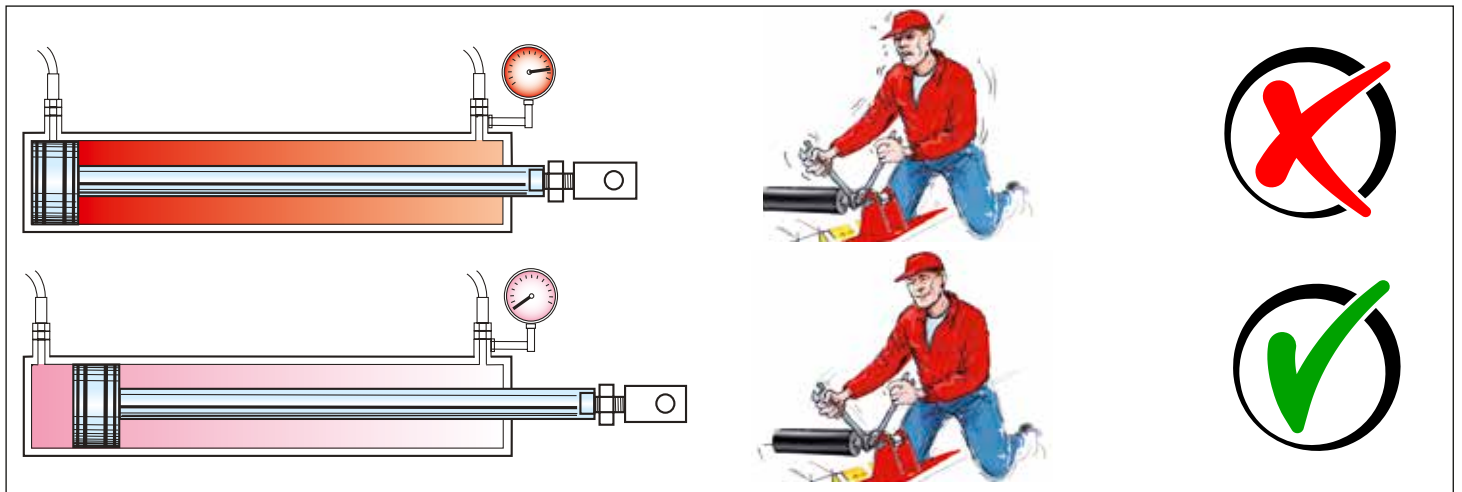
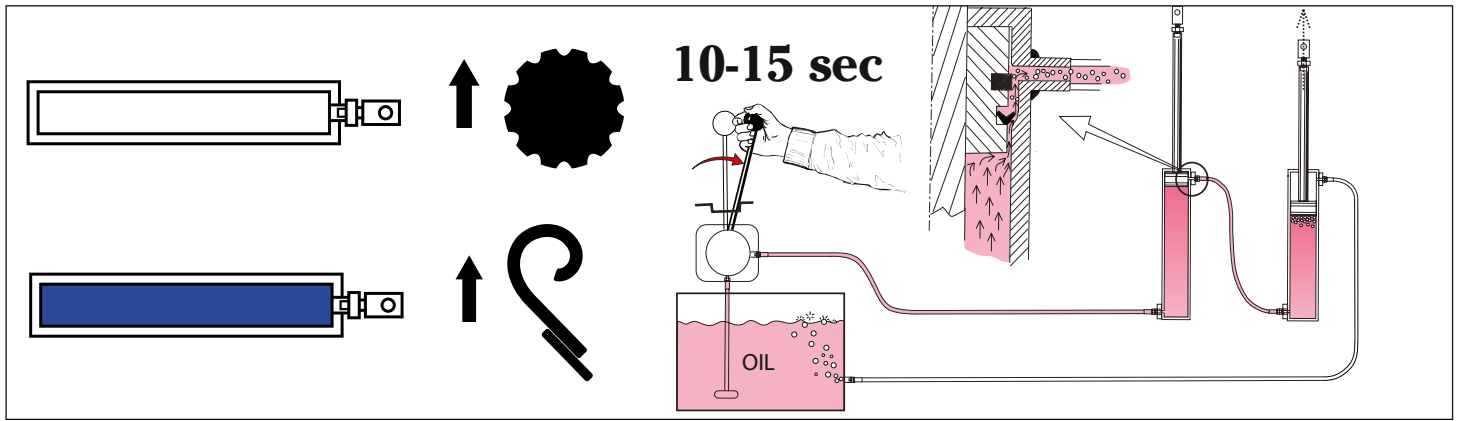

1 A

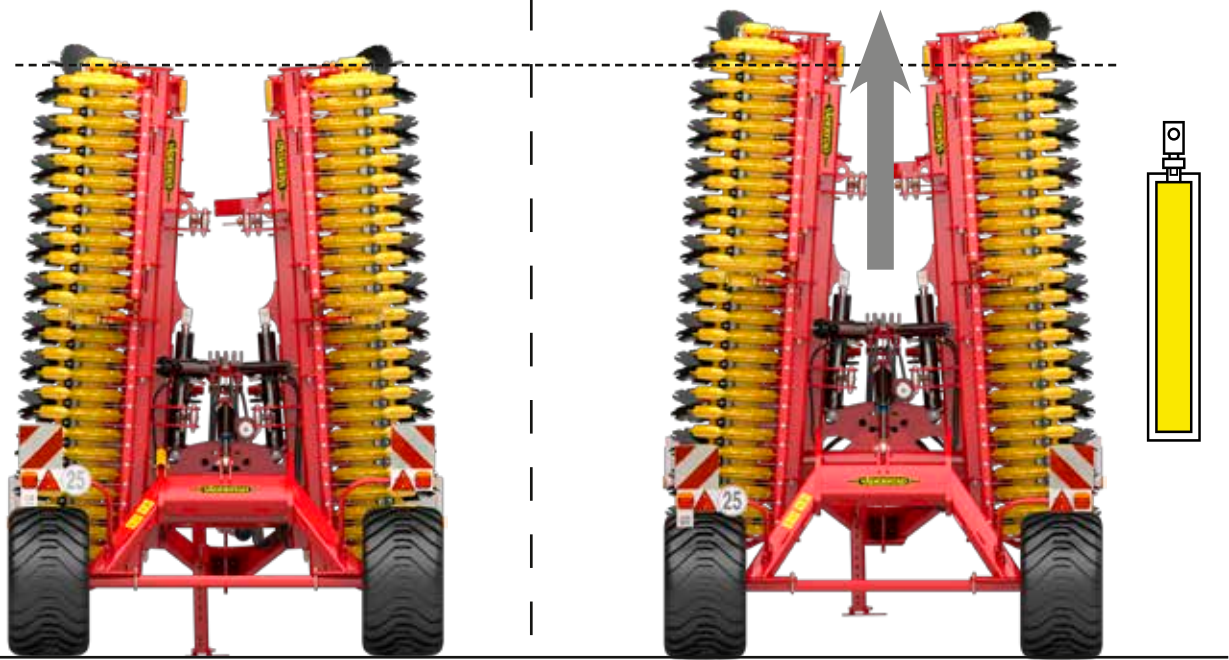

B

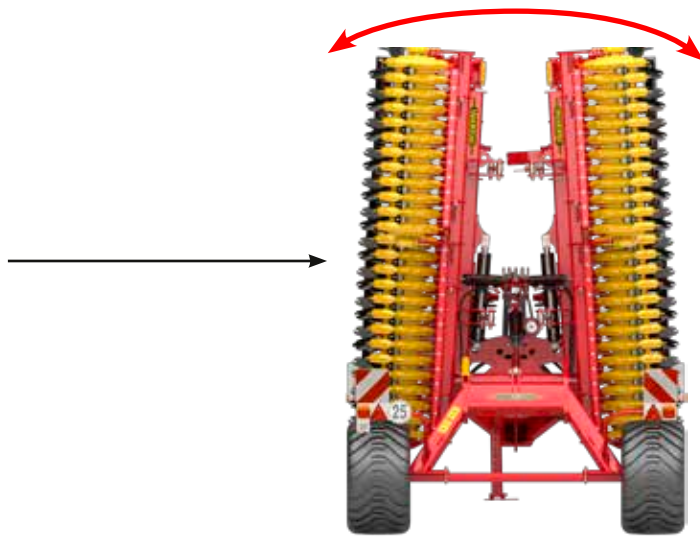

C



D

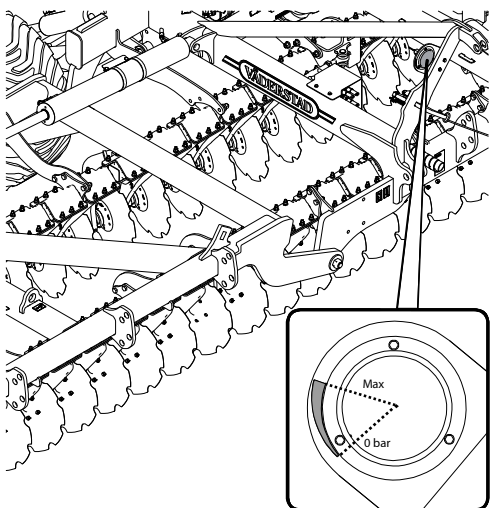

625-825 0-50 BAR



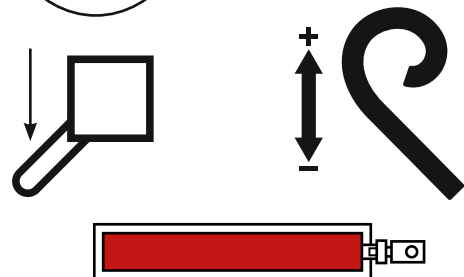
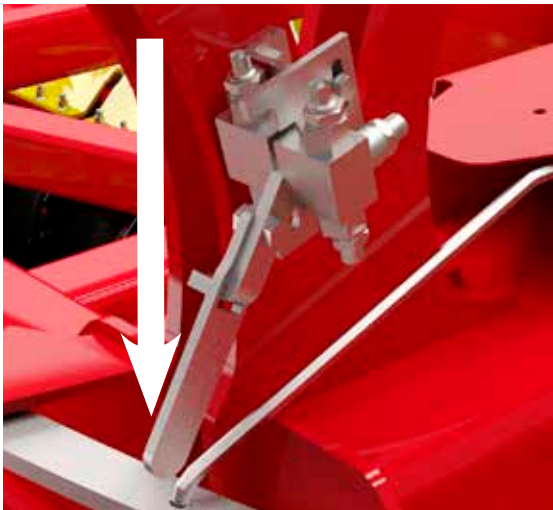
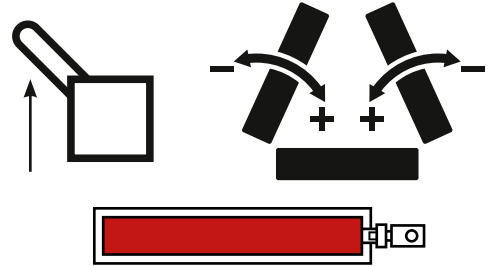
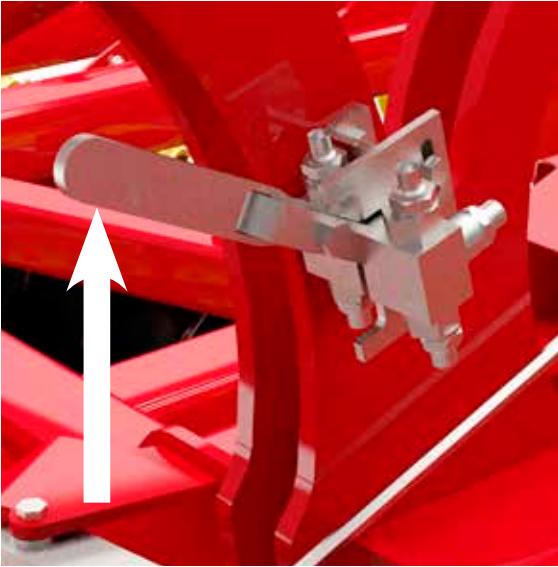

3:1



3:2_A

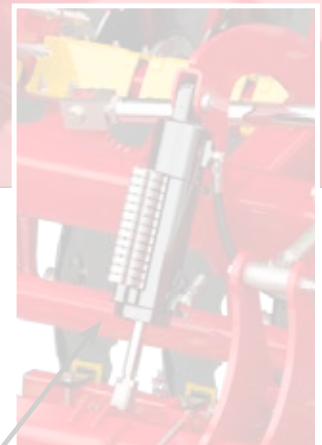

B

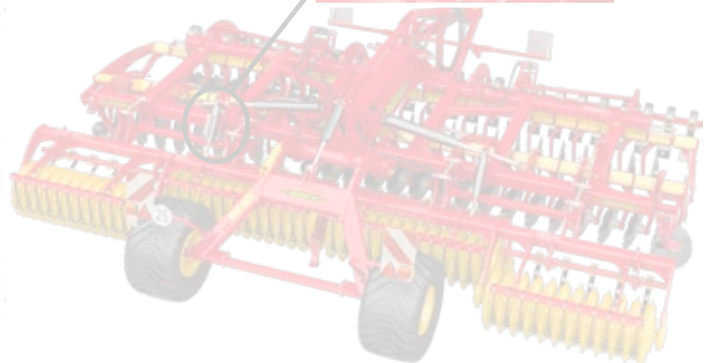
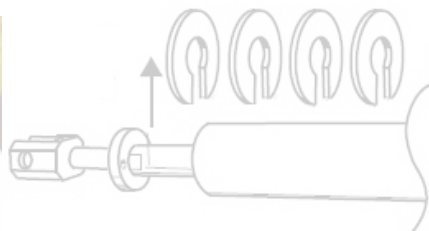
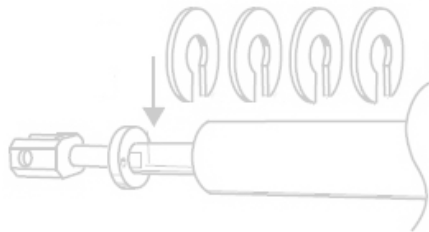

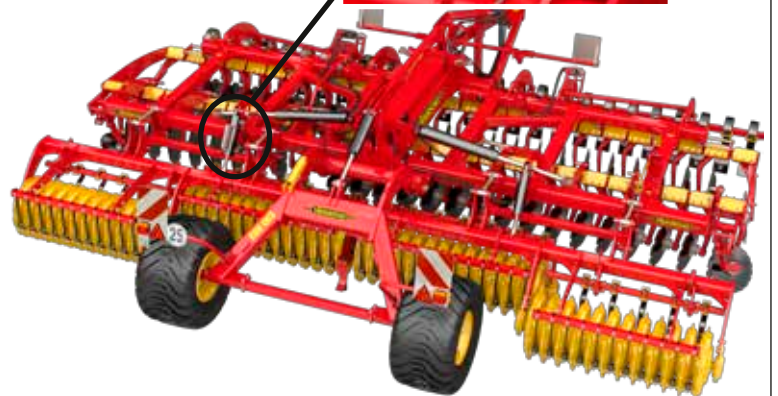
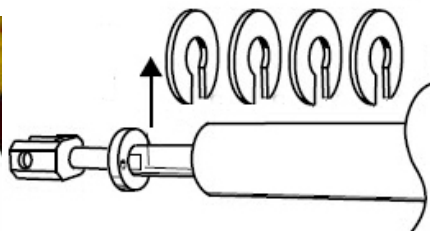
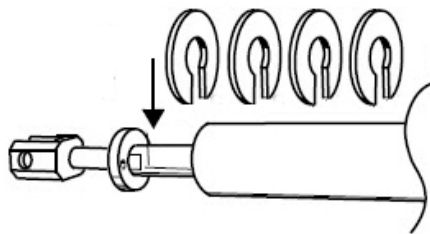

4

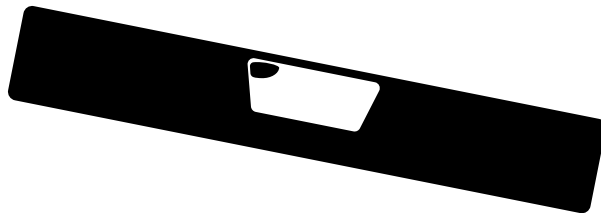
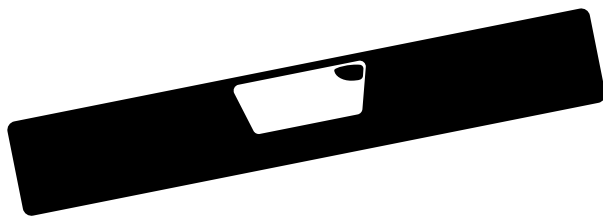

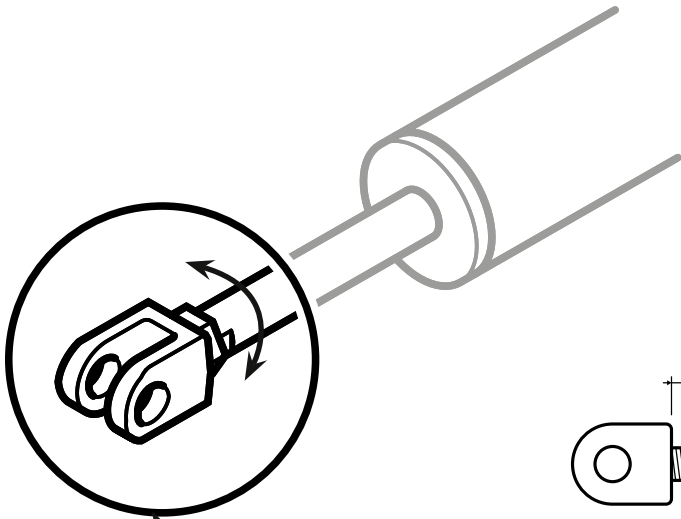

MAX 20mm

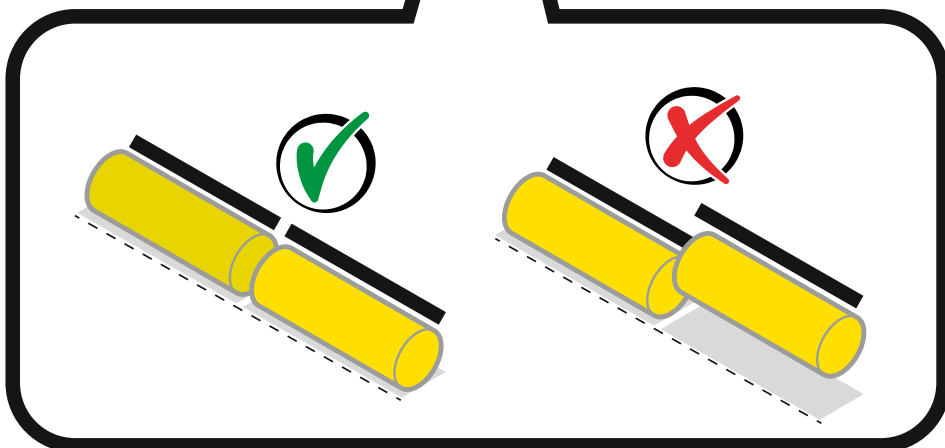
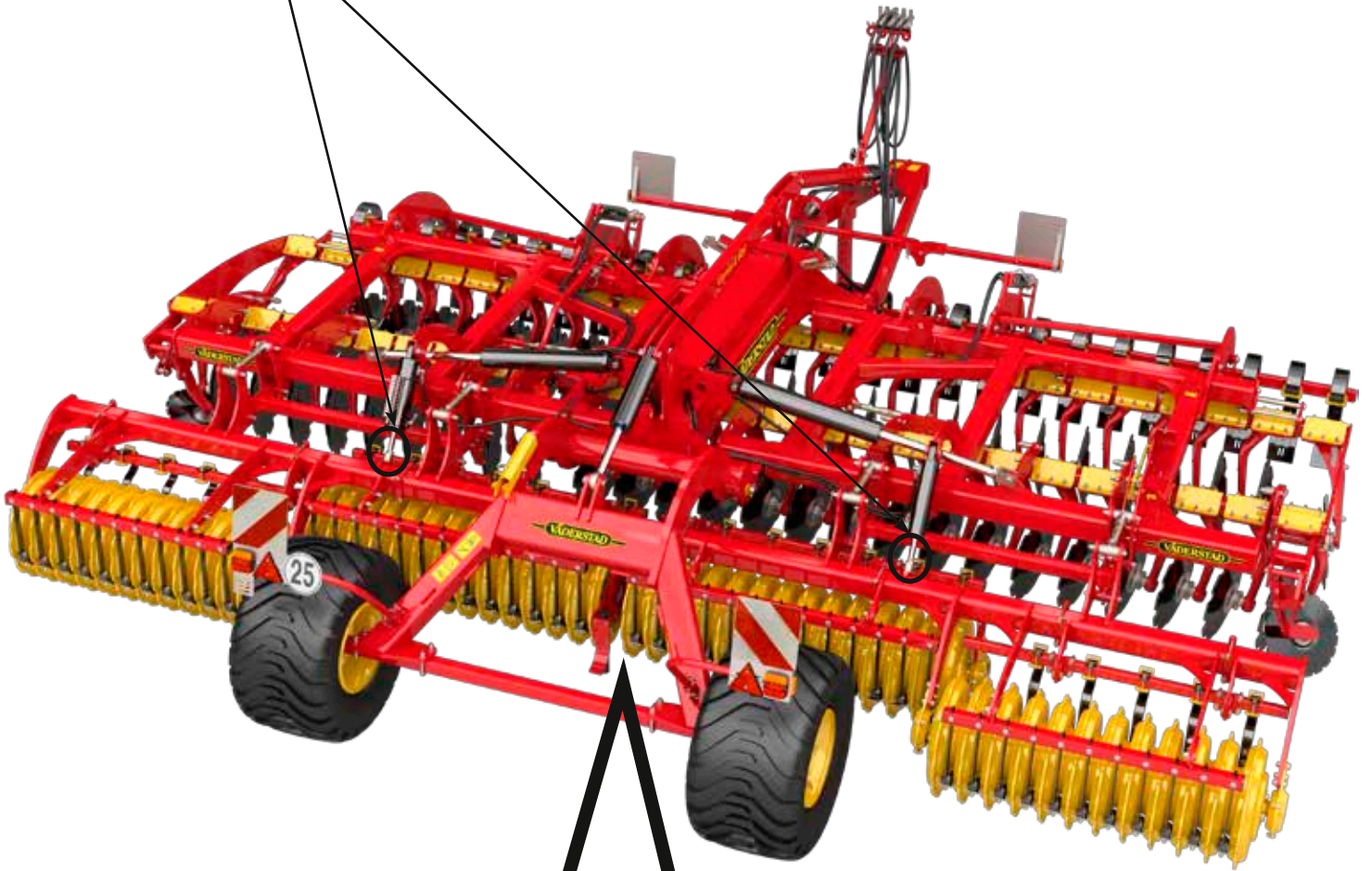
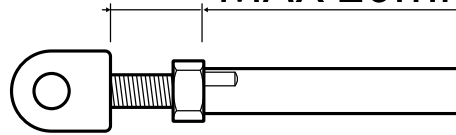

6



$a \geq b$

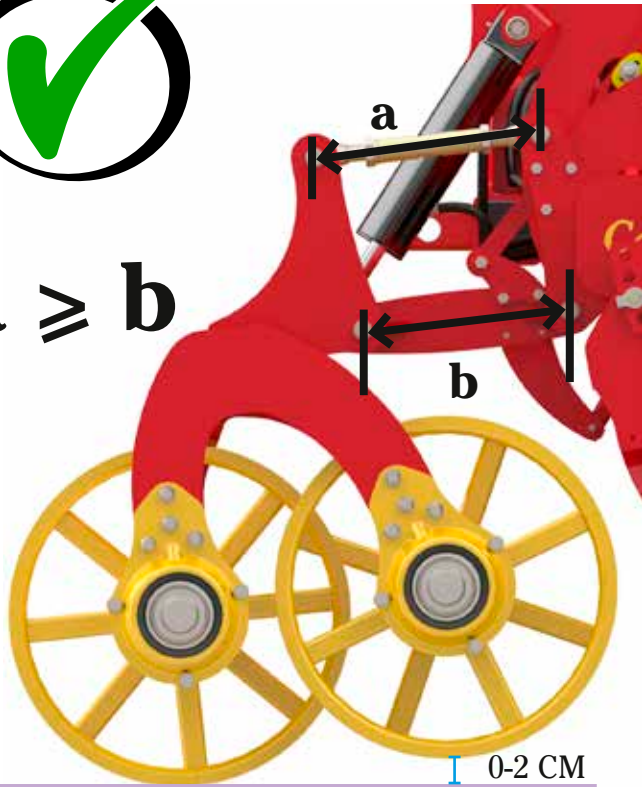

$a < b$

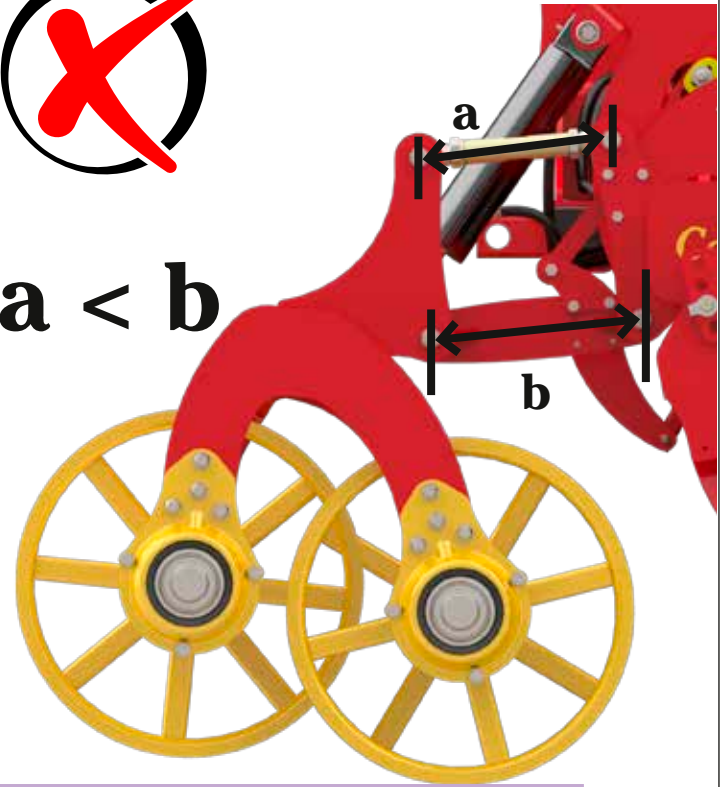

$a = b$

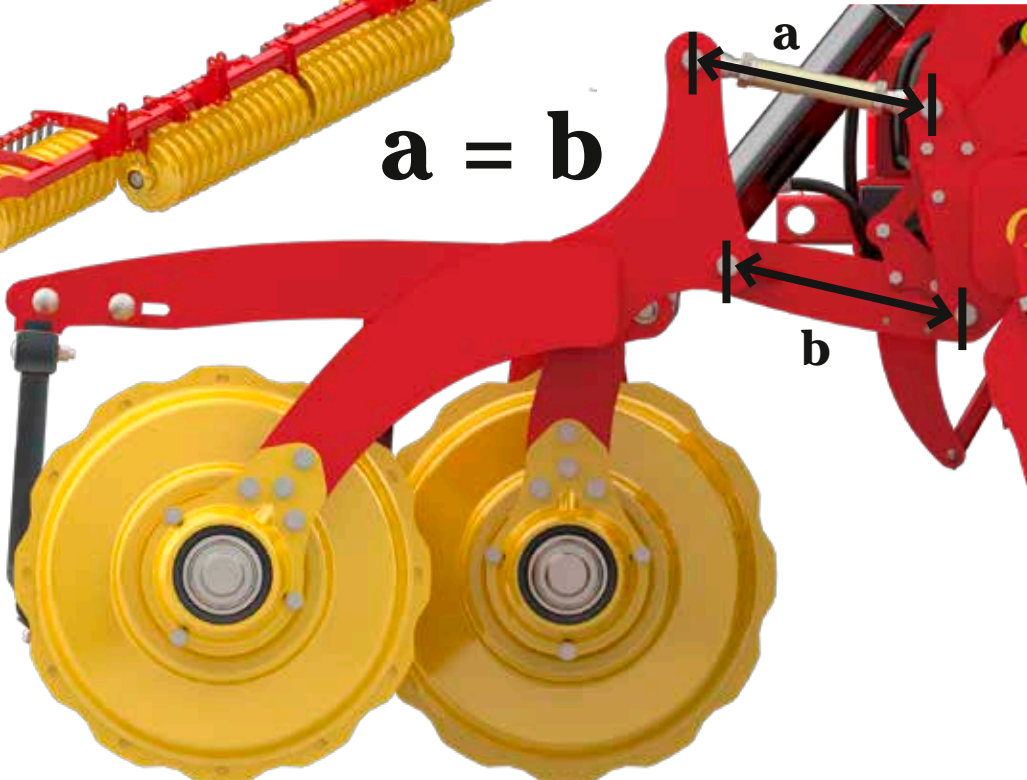

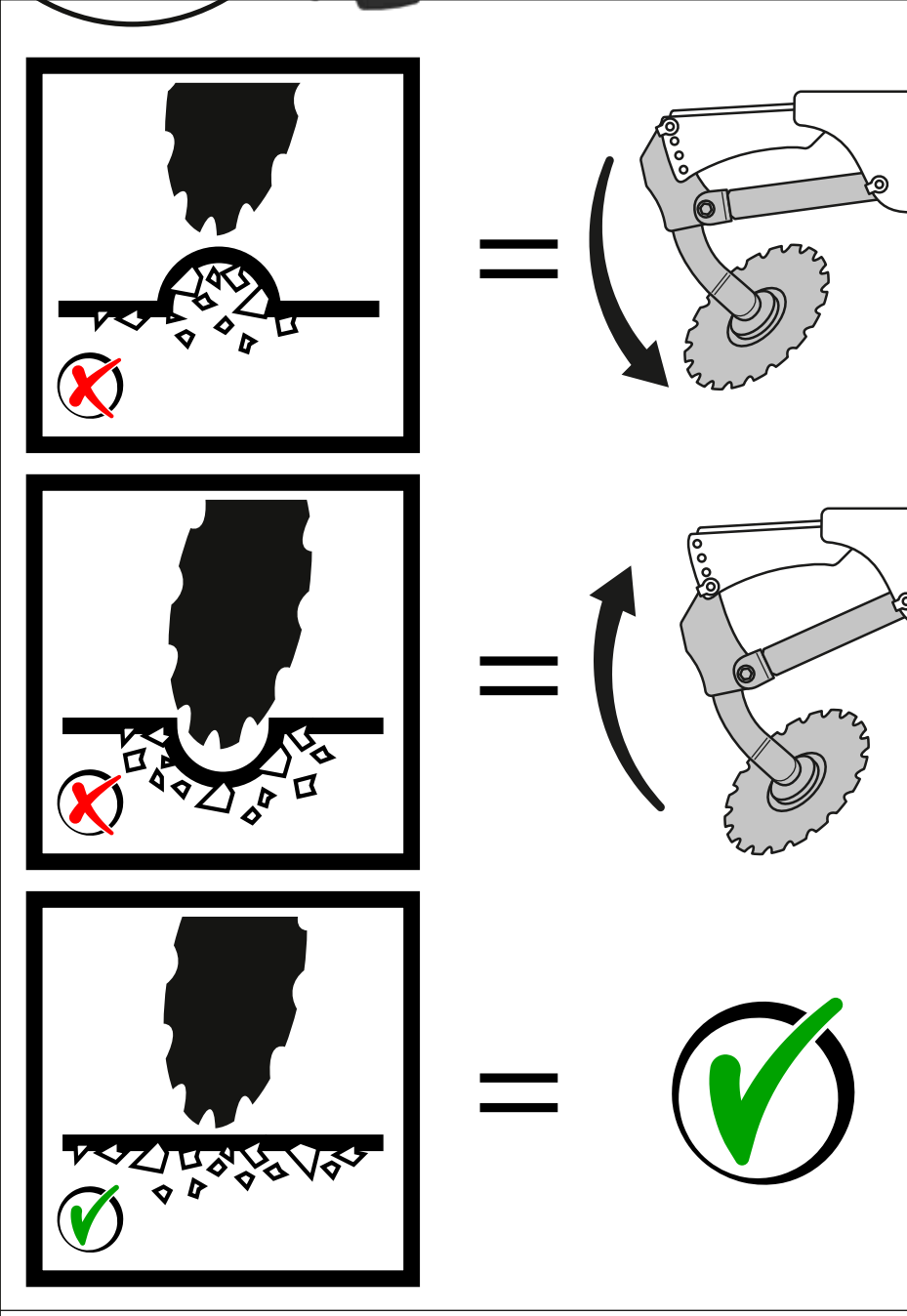
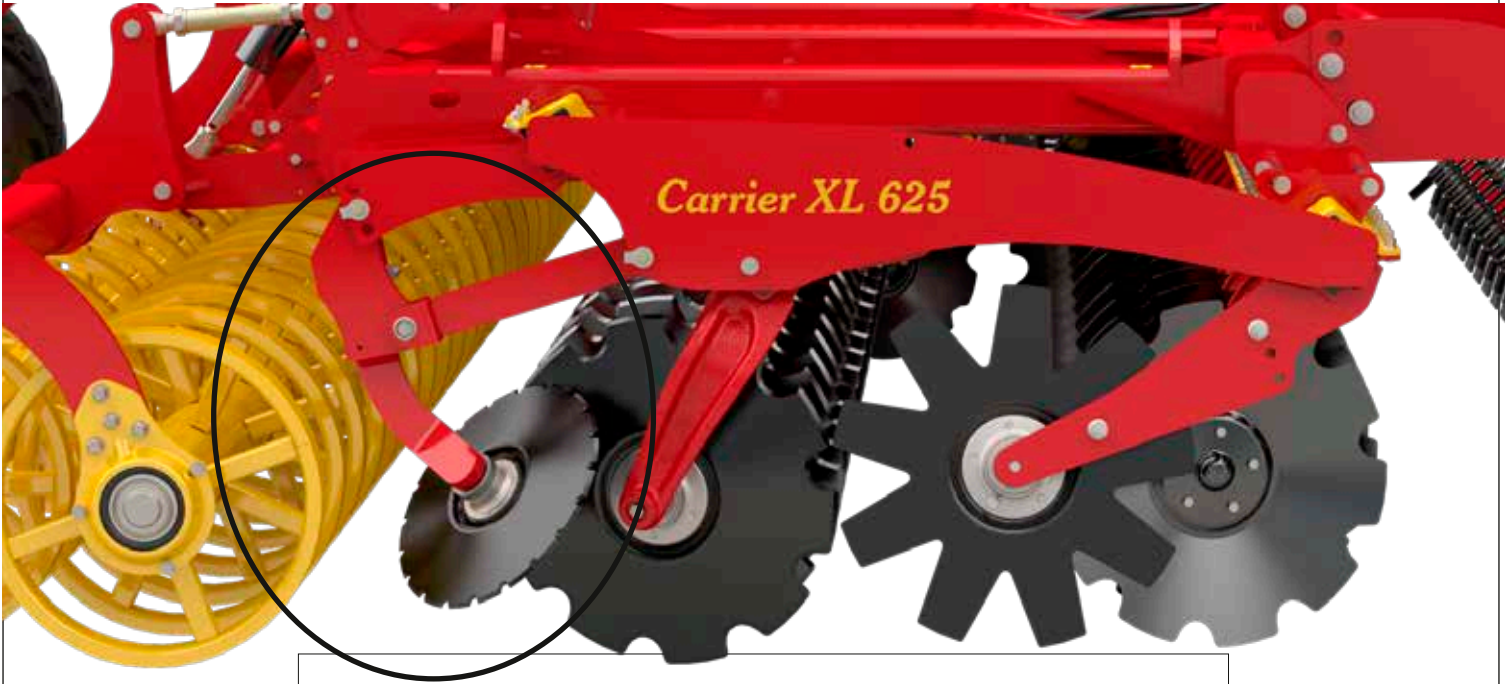

8

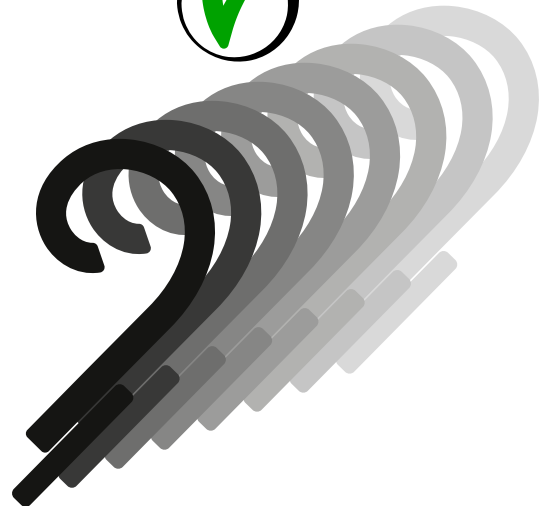
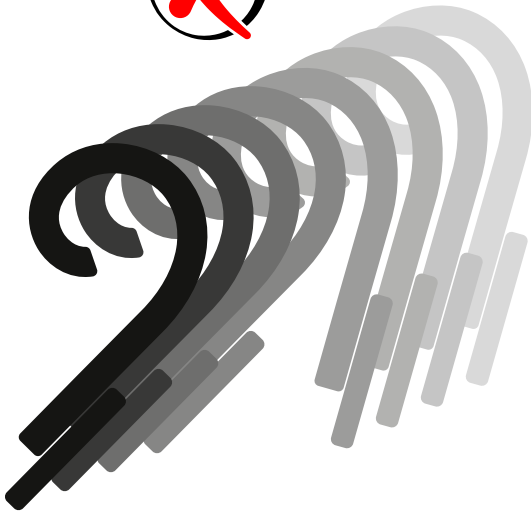
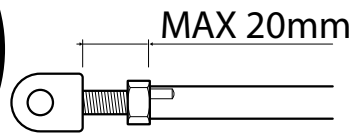
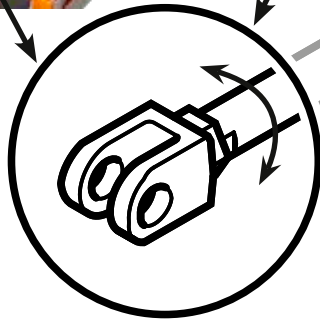

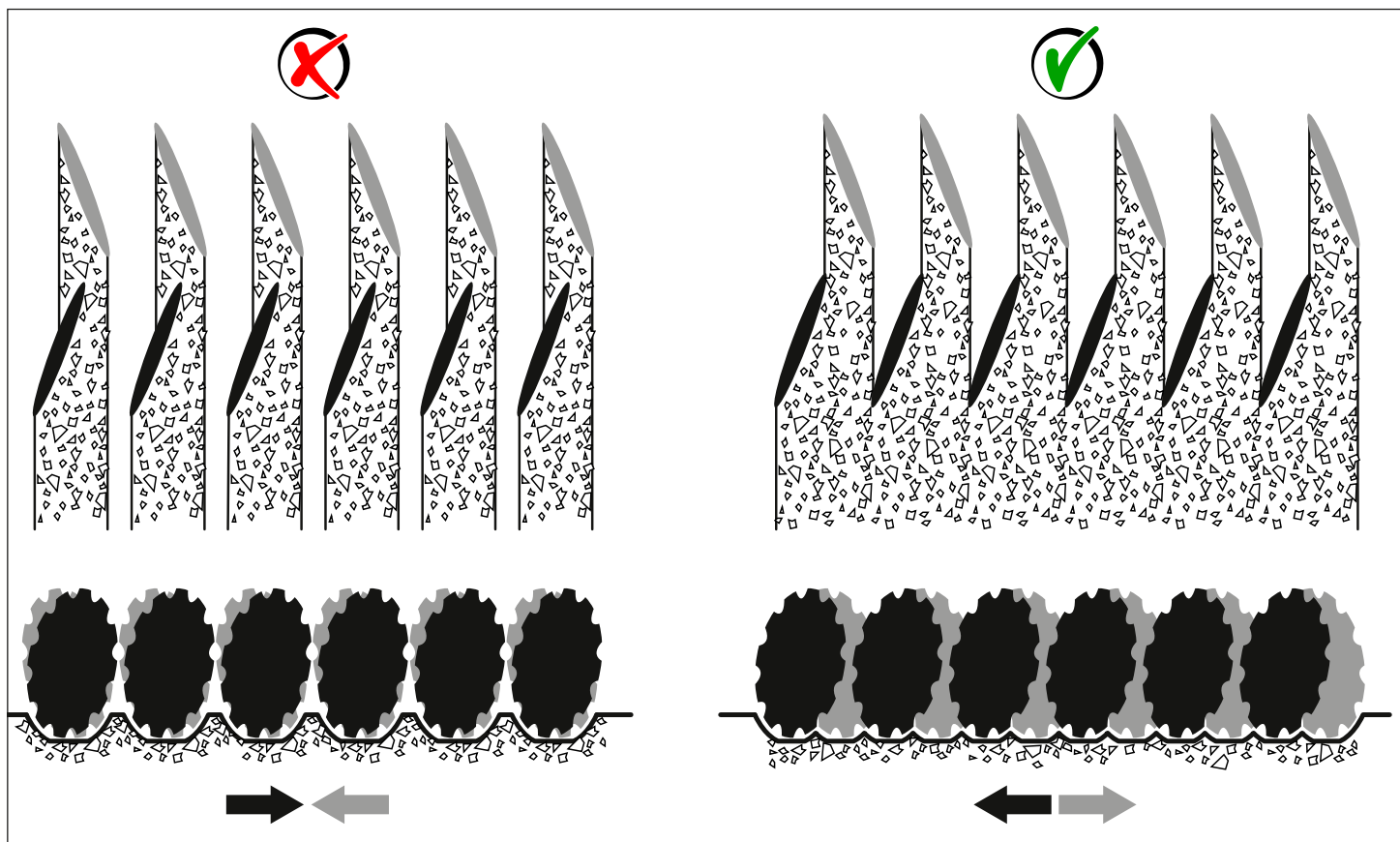
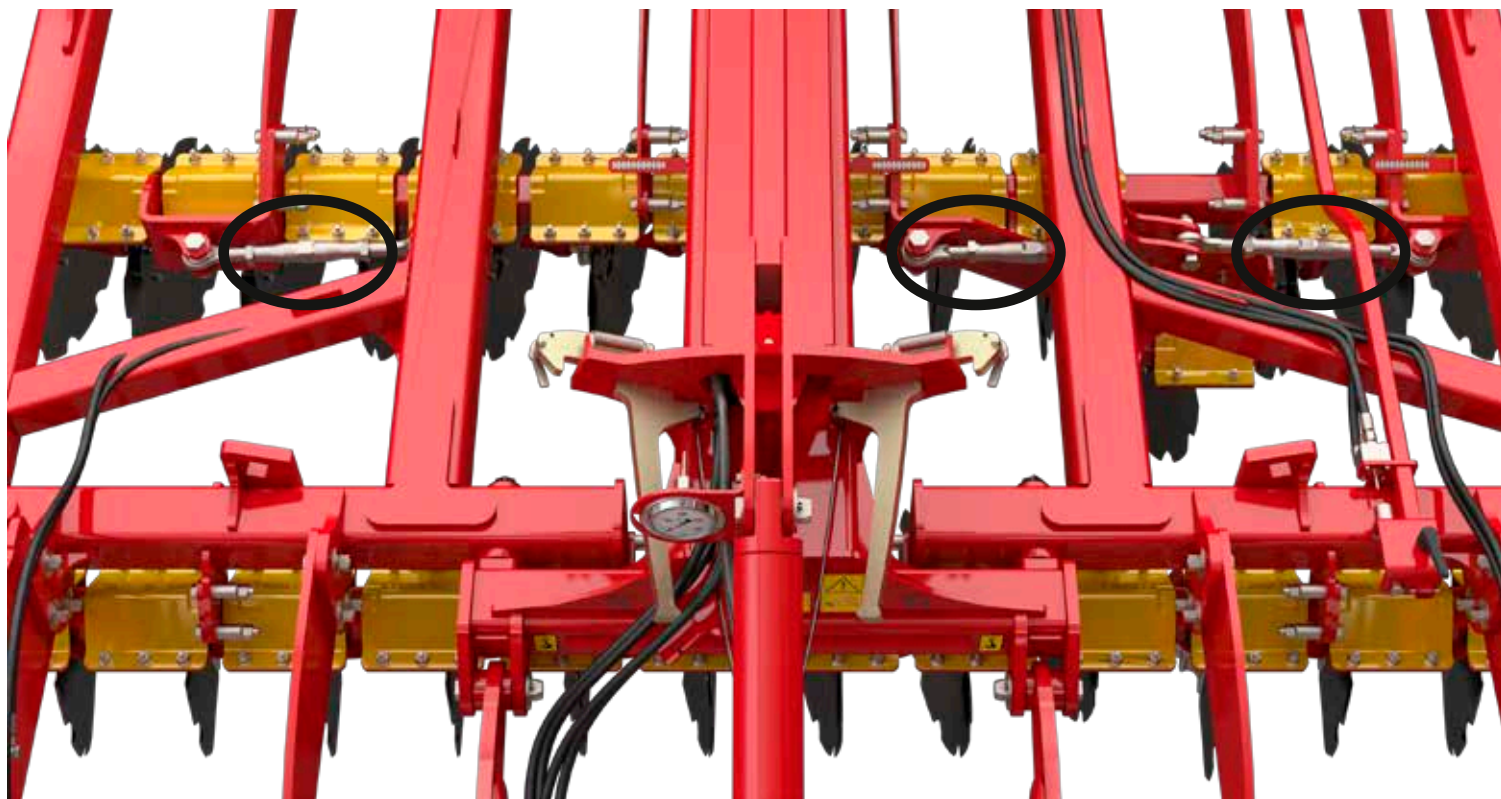

10





12_A



B

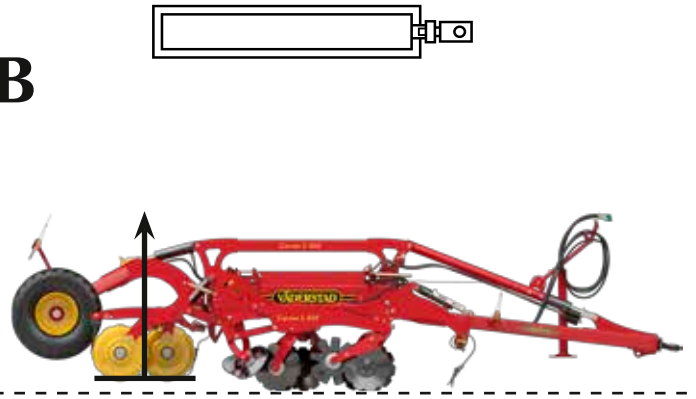

C

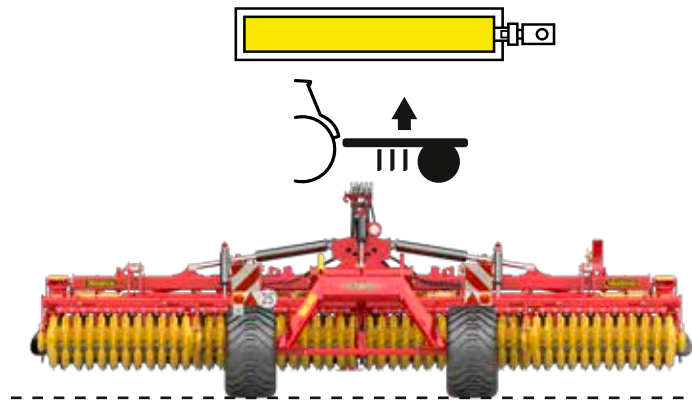

D

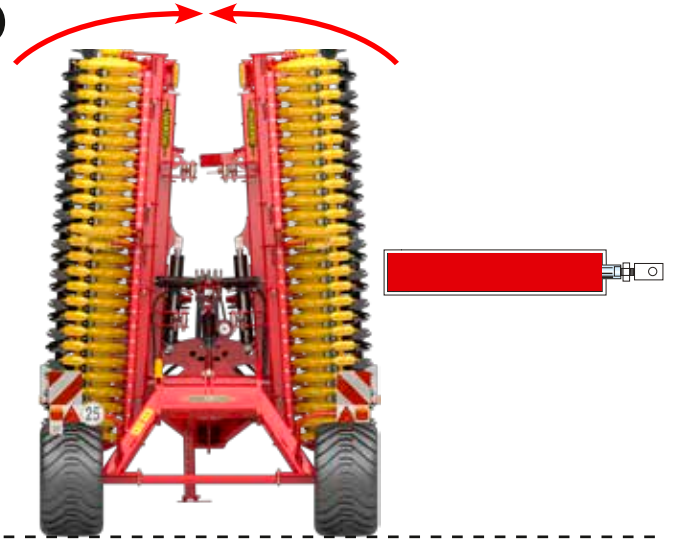

E



①

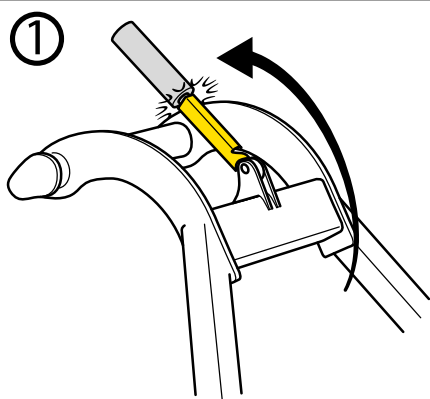

②

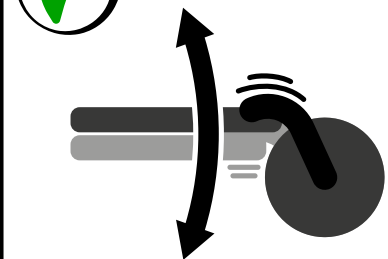
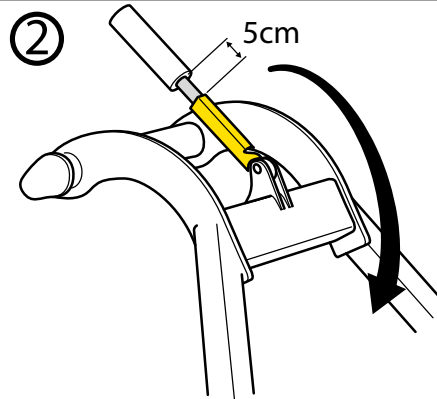

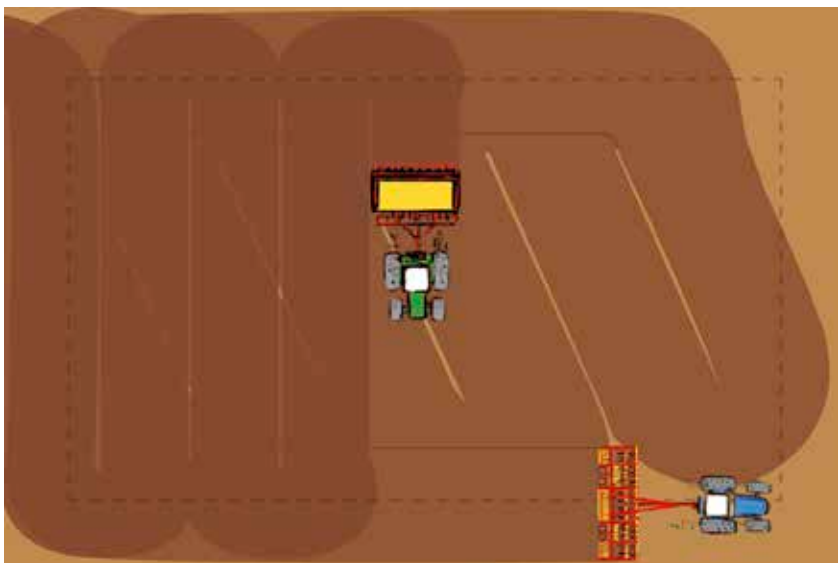
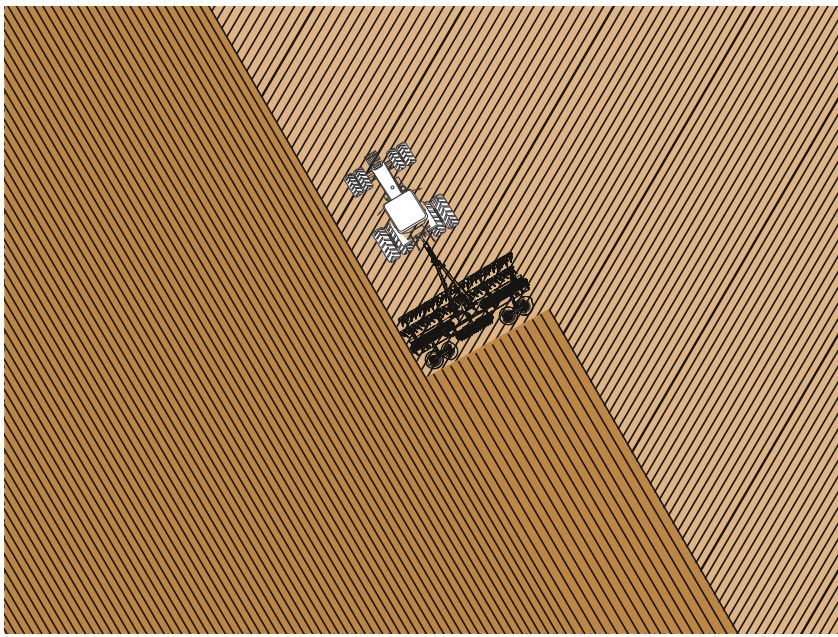
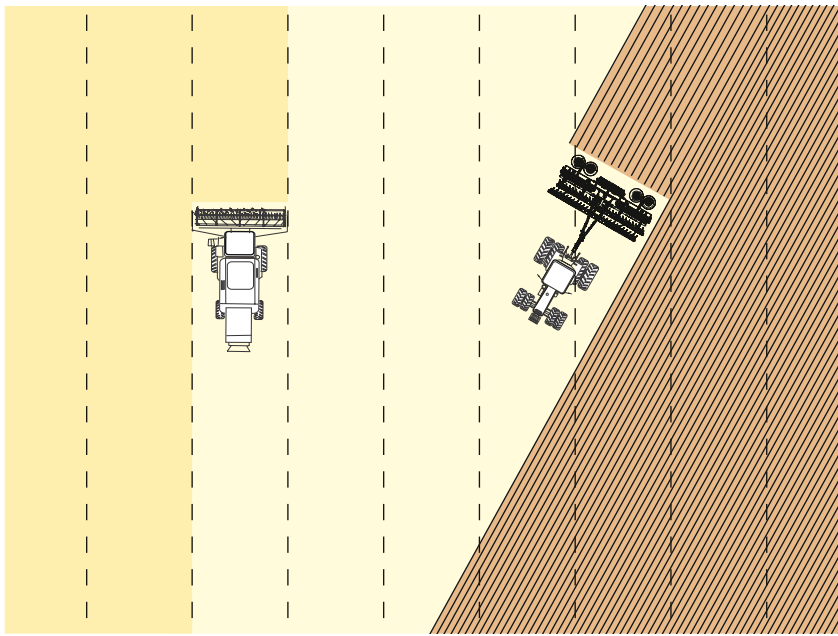

Notes

Notes

Väderstad AB
SE-590 21 VÄDERSTAD
Sweden
Phone: +46 142- 820 00



www.vaderstad.com